

FreshWater Installation Guide & Technical Information



Thank you for purchasing a FreshWater stainless steel water filter system.

Your FreshWater filter system is designed to connect exclusively to FreshWater filtration taps. The component parts of the system are precision manufactured to the highest quality standard, using premium food grade materials. Correctly installed and maintained your FreshWater water filter will provide many years of trouble free use and a convenient, secure supply of high quality drinking water. Your system is supplied as a complete system with the parts required for connection to your FreshWater filter tap and the cold mains water, including a Pearl multi-stage filter cartridge.

Replacement Filter Cartridges

We recommend that only genuine replacement cartridges and spare parts are used to service your FreshWater. These can be obtained on-line at www.freshwaterfilter.com or call **0845 177 0896**

Filter Cartridge Replacement Period

The Pearl filter cartridge should be replaced at 6 monthly intervals in order to maintain their filtration performance.

Please keep this guide in a safe place. It will enable you to get the best performance from your FreshWater filter now and in the future.

Section 1 Important Things to Consider

Water Supply (Water Fittings) Regulations 1999

Familiarise yourself with the requirements of the Water Supply Regulations 1999: www.legislation.gov.uk/uksi/1999/1148/contents/made

Maximum Working Pressure 6 bar/90psi.

Measure the pressure during the 'low demand' period, when the pressure will be at its highest- e.g. in the mid-morning, mid-afternoon or late evening. If the pressure exceeds 6 bar/90psi, it will be necessary to install a suitable pressure reducing valve in the supply line upstream of the filter stop valve.

Minimum Pressure 1.5 bar/23psi

This is the minimum pressure recommended to achieve an acceptable flow.

Filter Housing

The filter housing is precision engineered in 304 stainless steel and will require no routine maintenance beyond regular lubrication of the large sump 'O' Seal (see Lubrication below) and an occasional wipe with a damp cloth.

Lubrication

Applying a smear of grease to the large 'O' seal on the head of the housing at each cartridge change will ensure the two parts of the filter housing are easy to separate and re-assemble. **Important.** Use only WRAS (Water Research Advisory Service) approved silicon grease to lubricate the rubber seals as rubber and plastic parts will degrade and eventually fail if the wrong grease is used. A suitable grade of silicon grease is available to purchase online at www.freshwaterfilter.com

Sensible Precautions

If you are planning to leave the premises where the filter is installed for an extended period, turn off the water supply to the filter using the filter service stop valve, then operate the filtered water tap on and off again to release the pressure in the system.

Section 2 Planning your Installation

Although your FreshWater system is designed for ease of installation, careful planning and preparation before commencing the installation will ensure the procedure is straightforward and trouble-free.

Choosing the Location

When deciding where to position both the stop valve and the filter housing, bear in mind the need for easy access to make future filter cartridge changes a simple process. Ensure the terminations of the two braided flexible hoses are within easy reach of their respective connections to avoid stretching the hoses.

Installing the Filter System above the Ground Floor

Extra care should be taken when installing water appliances above the ground floor. To reduce the risk of potentially catastrophic flooding, install an automatic shut-off device at the outlet of the filter stop valve.

Backflow Prevention

To comply with UK Water Supply (Water Fittings) Regulations 1999, a suitable check valve (non-return valve) arrangement should be installed upstream of the filter stop valve.

Plumbing Connections

The stop valve supplied with the system is for connection to 15mm copper pipe. For alternative connection options please contact FreshWater customer service.

Continued overleaf....

Section 3 Principal Components

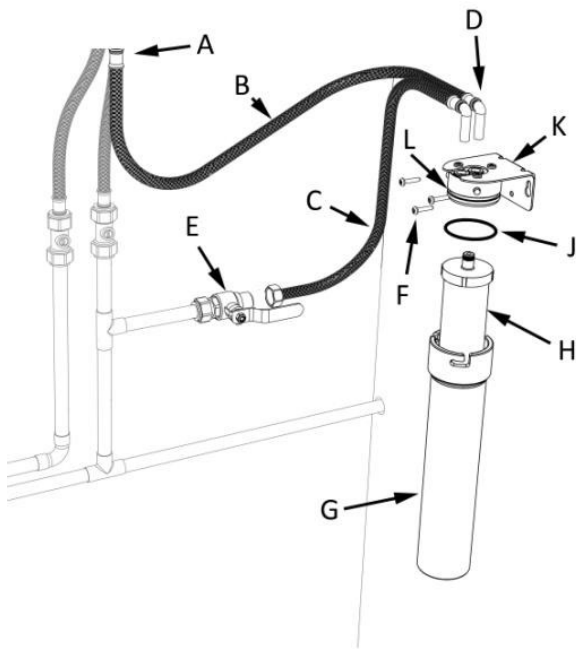

	Part
A	Connect to filter tap
B	White Plastic Outlet Tube
C	Inlet Hose
D	3/8" to 1/4" Stem Elbow
E	15mm Stop Valve
F	3 x Wood Screws
G	Filter Sump
H	Filter Cartridge
J	Head 'O' Seal
K	Wall Bracket
L	Filter Head Assembly

Section 4 Installation

Shut off the mains water supply

Install the stop valve

The stopvalve (E) supplied is 15mm compression to a 1/2 inch BSP male. A suitable tee piece will need to be plumbed in 15mm pipe work conveniently located within easy reach of the inlet hose connecting nut.

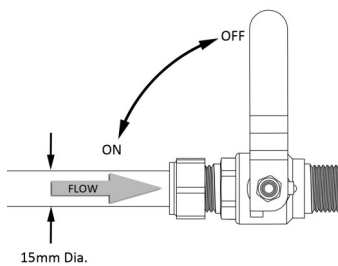

Fitting the filter housing bracket

Mark the positions for the two securing screws (F) and screw them in. Allow approximately 2 mm below the head of the screw to protrude to allow the bracket (K) to be easily located on and off the screws.

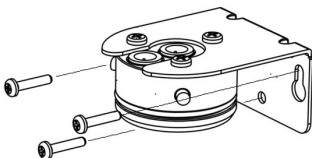

Section 4 Continued—Installation

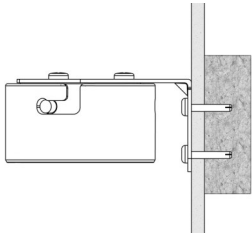

Note Depending on the nature of the cabinet it may be necessary to position a batten behind the panel to make secure fixing. Remember the weight of the housing will increase when filled with water.

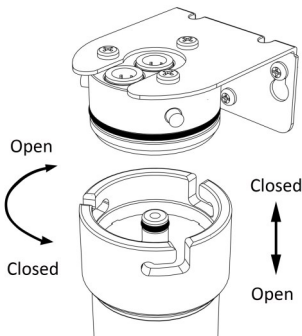

Install the filter cartridge and assemble the filter housing. Unscrew the housing to separate the head (E) from the sump (H). Holding the head in one hand screw the filter cartridge carefully in place, being careful not to over tighten it (see section 8 cartridge change instructions). Reassemble the housing to the sump and hand tighten it firmly.

Connect the braided inlet hose to the filter housing and the stop valve Select the braided hose (J). Connect the end with the 1/2" BSP female nut on to the stop valve (K). Hand tighten the nut and use a spanner to tighten it a further half turn to make a watertight seal - **Do not over tighten**

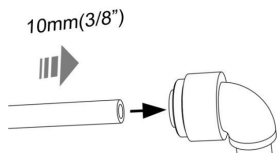
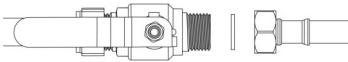

Connect the filter tap to the outlet of the filter housing

Refer to the separate tap installation instructions included with the filter tap you have selected. Take the length of 1/4" diameter white tube supplied with the filter kit. Connect one end of this tube to the filtered water inlet of tap in accordance with the tap instructions.

Take the free end of the 1/4" diameter white tube and make the connection to the push fit connector in the outlet of the filter housing.

Important note – make sure that the 1/4" tube is pushed fully home in to the connector. Initial resistance will be felt as the tube engages the internal 'O' seal – continue to firmly push the connector past the seal to the final stop. As a guide 10mm (3/8") of the tube should enter the connector. Failure to fully engage the connector may cause the joint to leak or possibly fail completely.

Turn the water on

Check to make sure all the connections are secure. Close the stop valve (E) and turn the lever of your filter tap to the 'ON' position. Operate stop valve (E) to turn on the mains water supply. Check that the filtered water is running from the tap spout. Allow the water to run for 5 minutes to flush the system and condition the cartridge.

Important for optimum removal performance adjust the stop valve to set the filtered water flow to fill a one litre jug in approximately 30 seconds.

Check the installation for leaks

Turn off the filter tap and carefully check the whole system for leaks, particularly at the connections to the stop valve, housing and tap. Turn on filter tap and allow the filtered water to run for approximately 10 minutes to clear any manufacturing or installation residues. Your FreshWater filter is now ready to use (as a precaution we recommend checking for leaks again before retiring for the night).

Section 5 Maintenance

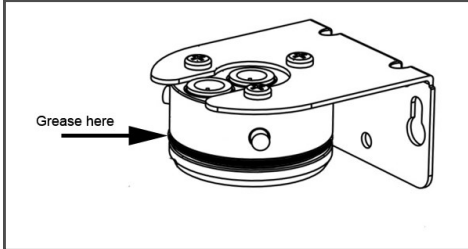

Routine maintenance

Apart from scheduled filter cartridge replacement, the filter unit will require very little routine maintenance beyond occasional lubrication of the head 'O' Seal.

Important, use only an approved silicon grease for this purpose- if you are unsure which grease to use please visit the FreshWater website www.freshwaterfilter.com or contact customer service on 0845 177 0896.

Section 6 Frequently asked questions

Limescale still forms in my kettle

The Pearl cartridge supplied as standard with FreshWater systems will not reduce limescale. It is first and foremost a health and security cartridge, designed to significantly reduce possible harmful waterborne contaminants in both hard and soft water regions. Calcium and magnesium, the minerals associated with limescale in water, are left intact as they are considered beneficial to health and contribute to its pleasant taste. However, if the cosmetic concern relating to scale reduction is your primary concern, you can switch to a Crystal cartridge on your next cartridge change date. Visit www.freshwaterfilter.com for more information and to view the range of specialist cartridges.

Unightly deposits on the surface of a cup of tea.

In hard water areas a 'scum' can appear on the surface of hot tea. Although unsightly it is completely harmless. The cause is related to the precipitation of calcium and magnesium in hard water regions and a reaction with the tea bag material. Changing tea bags will often remedy the problem. Alternatively you can consider switching to a Crystal cartridge (refer to previous paragraph).

Milky water

With a new system a significant amount of air is trapped in the microporous structure of the cartridge. This will form tiny bubbles and give the water in the glass a milky appearance that will soon disperse when left to stand for a few moments. This may continue for 2 to 3 weeks until the cartridge is fully conditioned.

Tiny black specs in the water

Tiny black specs may appear initially in the water. These are harmless particles of carbon; residues from the manufacturing process. Allow the filtered water to continue flowing for a while until they are completely flushed through.

The filtered water flow slows to an unacceptable level

A significant reduction in flow is an indication that the ceramic shell of the cartridge is blocked with contaminants. This often occurs soon after a new system is installed due to plumbing residues, solder fluxes etc, becoming trapped on the surface of the filter cartridge. If this happens inside the recommended 6 month change cycle you may clean the cartridge to restore the flow. Remove the cartridge (refer to cartridge change instructions), hold the cartridge under warm running water and abrade the outer surface vigorously with a non soapy abrasive pad sufficiently to restore the white colour of the surface.

Section 7 Changing the cartridge

Cartridge Replacement Cycle

The recommended filter cartridge change cycle is 6 months

Important: The period between cartridge replacements is not guaranteed; it is an estimate based on filtering mains water of average quality. Please bear in mind that water quality varies from locality to locality and situation to situation. In areas with higher than average turbidity (particle contamination) more frequent cartridge changes may be necessary.

Before you begin

No special tools are required for this operation. All you will need is a suitable receptacle to catch any spillage and a cloth or a sponge handy. A rubber glove is provided to hold the wet cartridge.

Lubricating the rubber seals

For ease of assembly we recommend that a film of silicone grease is applied to the filter housing 'O' Seal at least every other cartridge change to maintain the smooth operation of the unit. **Important note** Only a WRAS approved silicon lubricant should be used for this purpose. Small tubes of a WRAS approved silicon grease can be purchased from FreshWater at www.freshwaterfilter.com

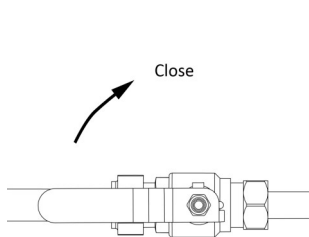

1. Locate the shut-off valve and turn off the mains water supply to the filter housing.

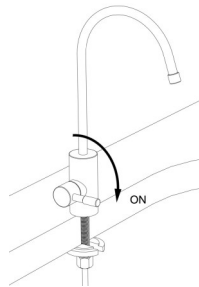

2. Turn on the dispenser tap to release the pressure in the system. Leave the tap in the 'on' position.

Important note. If the tap is not left 'on' the pressure trapped in the system will make it impossible to unlock the filter housing sump from the head.

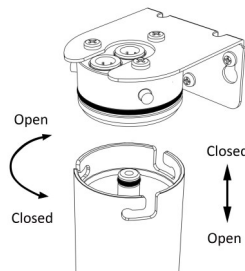

3. Firmly grip the sump with both hands. Turn to the left and pull down. The sump and the filter cartridge should come away together. The filter canister will be full of water so it is advisable to position a bowl to catch any spills.

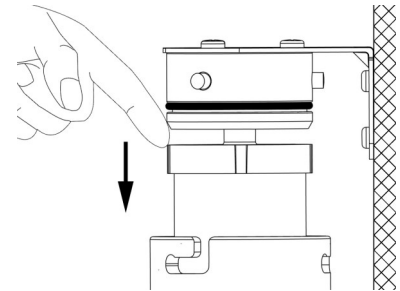

4. If the filter cartridge does not come away with the sump release it with an index finger by pushing down on the plastic rim.

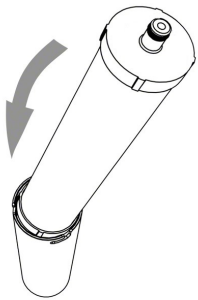

5. Holding the sump over the sink remove the spent cartridge and empty the water in the sump. Dispose of the spent cartridge. Place the new cartridge in the sump.

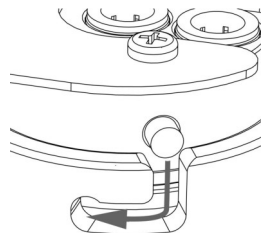

6. Refit the sump to the housing head by engaging the pins in the slots and turning the sump to the right until it is fully engaged.

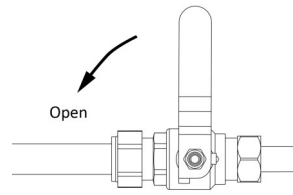

7. Turn on the water supply and check the system carefully for leaks. Leave the tap in the 'on' position and allow the water to run for a minimum of 10 minutes to flush the filter. Check the flow rate. We recommend no more than 30 seconds a litre for optimum performance. If the flow is too fast it can be regulated by adjusting the stop valve.

Section 8 Warranty

What is covered by the FreshWater guarantee?

- The repair or replacement of your drinking water filter system (at FreshWater's discretion) if your system is found to be defective due to faulty materials, workmanship or function within 5 years of purchase or delivery (whichever is later).
- If any part is no longer available or out of manufacture, FreshWater will replace it with a functional replacement part.
- Refurbished filter systems sold by FreshWater are covered for 2 years.
- Normal domestic use of the filter system in the UK and Republic of Ireland.

Terms and conditions of the FreshWater 5 year guarantee

- The guarantee becomes effective at the date of purchase (or the date of delivery if this is later).
- You must provide proof of delivery/purchase before any work can be carried out on your system. Without this proof, any work carried out will be chargeable. Please keep your receipt or delivery note.
- All work will be carried out by FreshWater or its authorised agents.
- Any parts which are replaced will become the property of FreshWater.
- The repair or replacement of your machine under guarantee will not extend the period of the guarantee.

The guarantee provides benefits which are additional to and do not affect your statutory rights as a consumer. What is not covered by the guarantee?

FreshWater does not guarantee the repair or replacement of a product as a result of:

- Normal wear and tear.
- Accidental damage, faults caused by negligent use or care, misuse, neglect, careless operation or handling of the filter system which is not in accordance with the FreshWater Operating Manual.
- Use of the filter system for anything other than normal domestic household purposes.
- Use of parts not assembled or installed in accordance with the instructions of FreshWater.
- Faulty installation (except where installed by FreshWater).
- Repairs or alterations carried out by parties other than FreshWater or its authorised agents.

If you are in any doubt as to what is covered by your guarantee, please call us on **0845 177 0896** between the hours of 9.00am and 5.00pm, Monday to Friday.

How do I make a claim under my FreshWater 5 year guarantee?

If you require assistance call us on **0845 177 0896**, between the hours of 9.00am and 5.00pm, Monday to Friday. If you are calling for the first time please have your receipt to hand so we can record your date of purchase. The receipt will also be required in the event of an engineer visit.

The company reserves the right to alter, change or modify product specifications without prior warning.